

21715-00004 | ATMS-01-01-01-03-00-00-XX

TYPICALLY USED ON MCNEILUS & OSHKOSH TRUCKS

Truck name does not guarantee hatch style, please verify all dimensions.

$\widehat{B} = 5-1/4"$

$\widehat{L} = 26-9/16"$

$A = 12-1/8"$

$R = 8"$

$H = 18-15/16"$

NOTES:

1. DIMENSIONS DENOTED BY $\widehat{}$ ARE TO BE MEASURED ON BEND RADIUS (ARC LENGTH).

CiDRA Concrete Systems Inc.
50 Barnes Park North
Wallingford, CT 06492
Main: +1.203.265.0035
Tech Support: +1.203.626.3430
smarthatchsupport@cidraconcrete.com
www.CidraConcrete.com

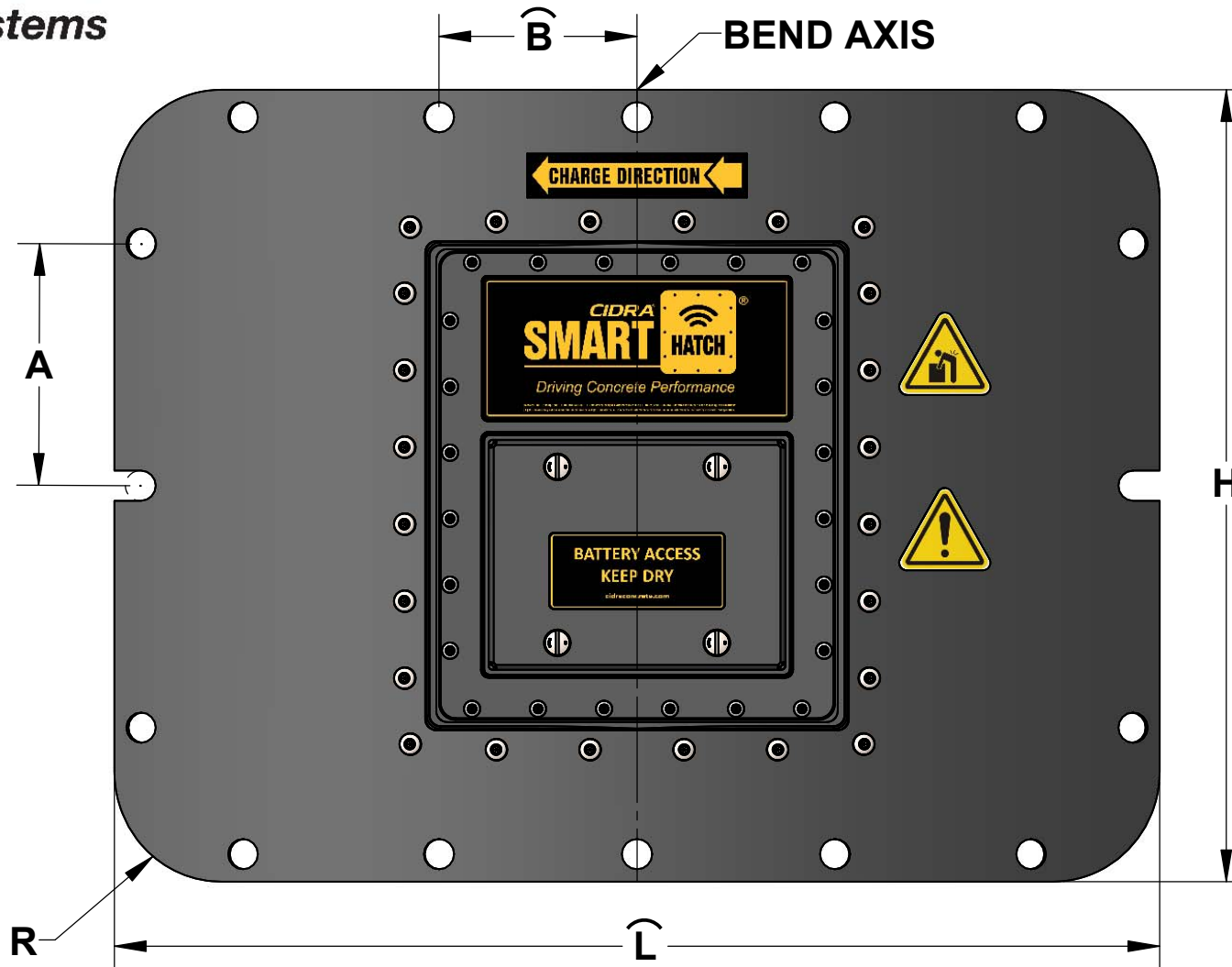

21715-00007 | ATMS-01-01-02-03-00-00-XX

TYPICALLY USED ON MCNEILUS, CON-TECH, & SHUMAKER TRUCKS
Truck name does not guarantee hatch style, please verify all dimensions.

NOTES:

1. DIMENSIONS DENOTED BY $\widehat{}$ ARE TO BE MEASURED ON BEND RADIUS (ARC LENGTH).

$$\widehat{B} = 4\text{-}1/2\text{'}$$

$$A = 5\text{-}1/2\text{'}$$

$$\widehat{L} = 24\text{-}1/16\text{'}$$

$$R = 2\text{-}1/2\text{'}$$

$$H = 18\text{'}$$

CiDRA Concrete Systems Inc.
50 Barnes Park North
Wallingford, CT 06492
Main: +1.203.265.0035
Tech Support: +1.203.626.3430
smarthatchsupport@cidraconcrete.com
www.CidraConcrete.com

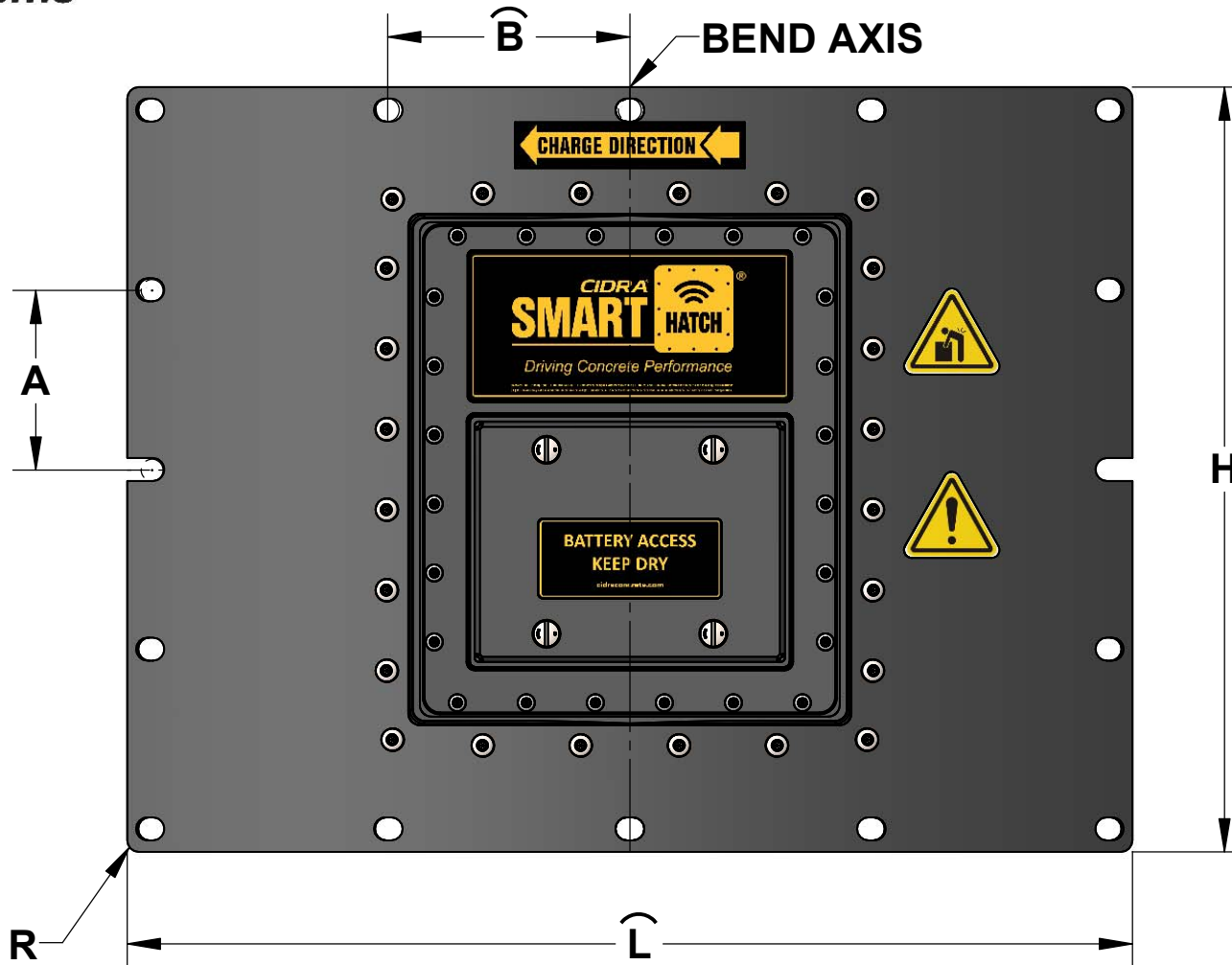

21715-00010 | ATMS-01-01-03-03-00-00-XX

TYPICALLY USED ON TEREX TRUCKS

Truck name does not guarantee hatch style, please verify all dimensions.

NOTES:

1. DIMENSIONS DENOTED BY $\widehat{}$ ARE TO BE MEASURED ON BEND RADIUS (ARC LENGTH).

$$\widehat{B} = 5\text{-}1/4\text{''}$$

$$A = 3\text{-}7/8\text{''}$$

$$\widehat{L} = 22\text{-}1/16\text{''}$$

$$R = 1/4\text{''}$$

$$H = 16\text{-}5/8\text{''}$$

CiDRA Concrete Systems Inc.
 50 Barnes Park North
 Wallingford, CT 06492
 Main: +1.203.265.0035
 Tech Support: +1.203.626.3430
smarthatchsupport@cidraconcrete.com
www.CidraConcrete.com

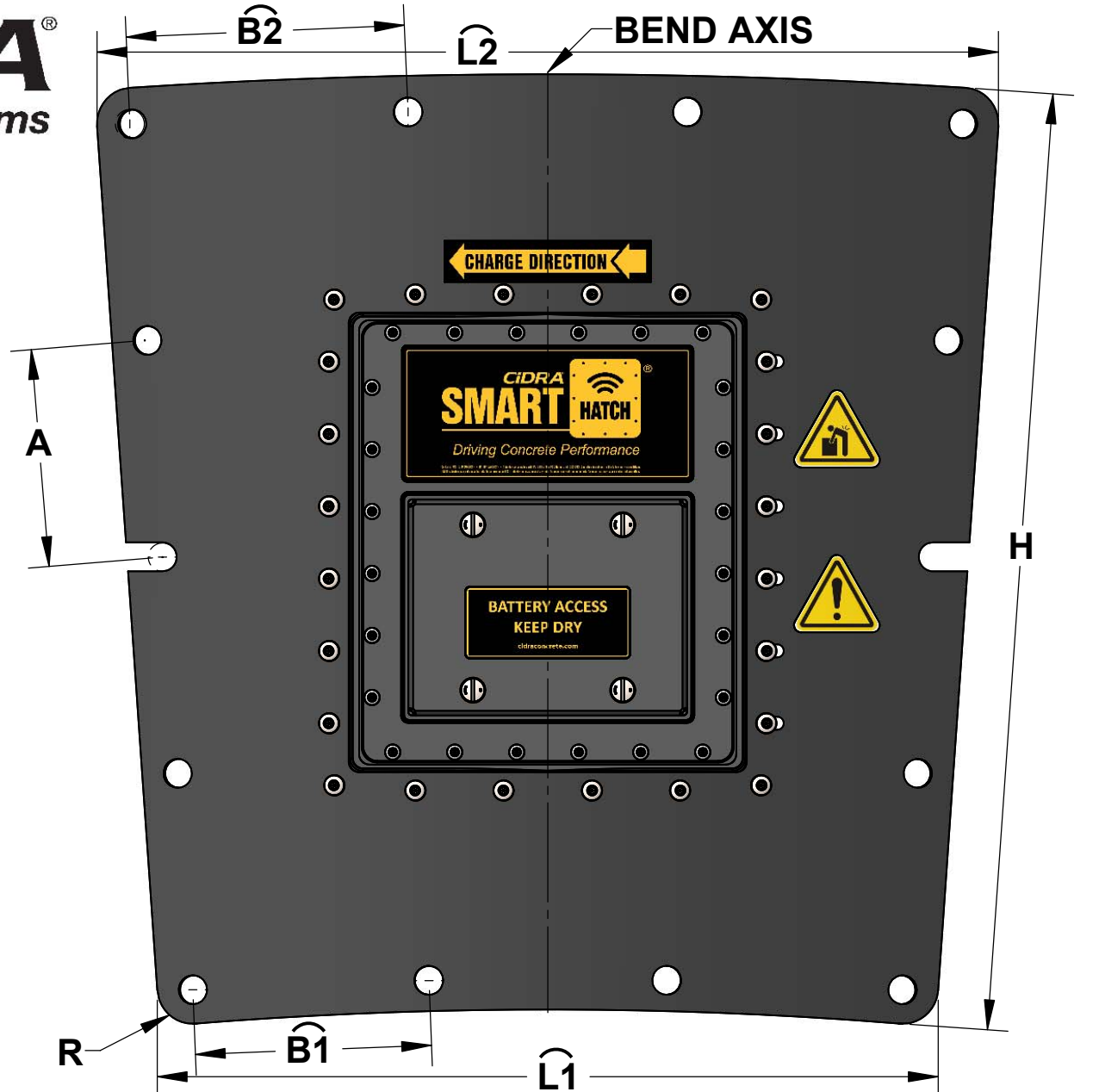

21715-00013 | ATMS-01-01-04-03-00-00-XX

TYPICALLY USED ON BECK TRUCKS

Truck name does not guarantee hatch style, please verify all dimensions.

NOTES:

1. DIMENSIONS DENOTED BY $\widehat{}$ ARE TO BE MEASURED ON BEND RADIUS (ARC LENGTH).

$\widehat{B1} = 5\text{-}3/4"$ $\widehat{B2} = 6\text{-}3/4"$ $\widehat{L1} = 18\text{-}7/8"$ $\widehat{L2} = 21\text{-}13/16"$
 $A = 5\text{-}1/4"$ $R = 7/8"$ $H = 22\text{-}11/16"$

CiDRA Concrete Systems Inc.
 50 Barnes Park North
 Wallingford, CT 06492
 Main: +1.203.265.0035
 Tech Support: +1.203.626.3430
 smarthatchsupport@cidraconcrete.com
 www.CidraConcrete.com

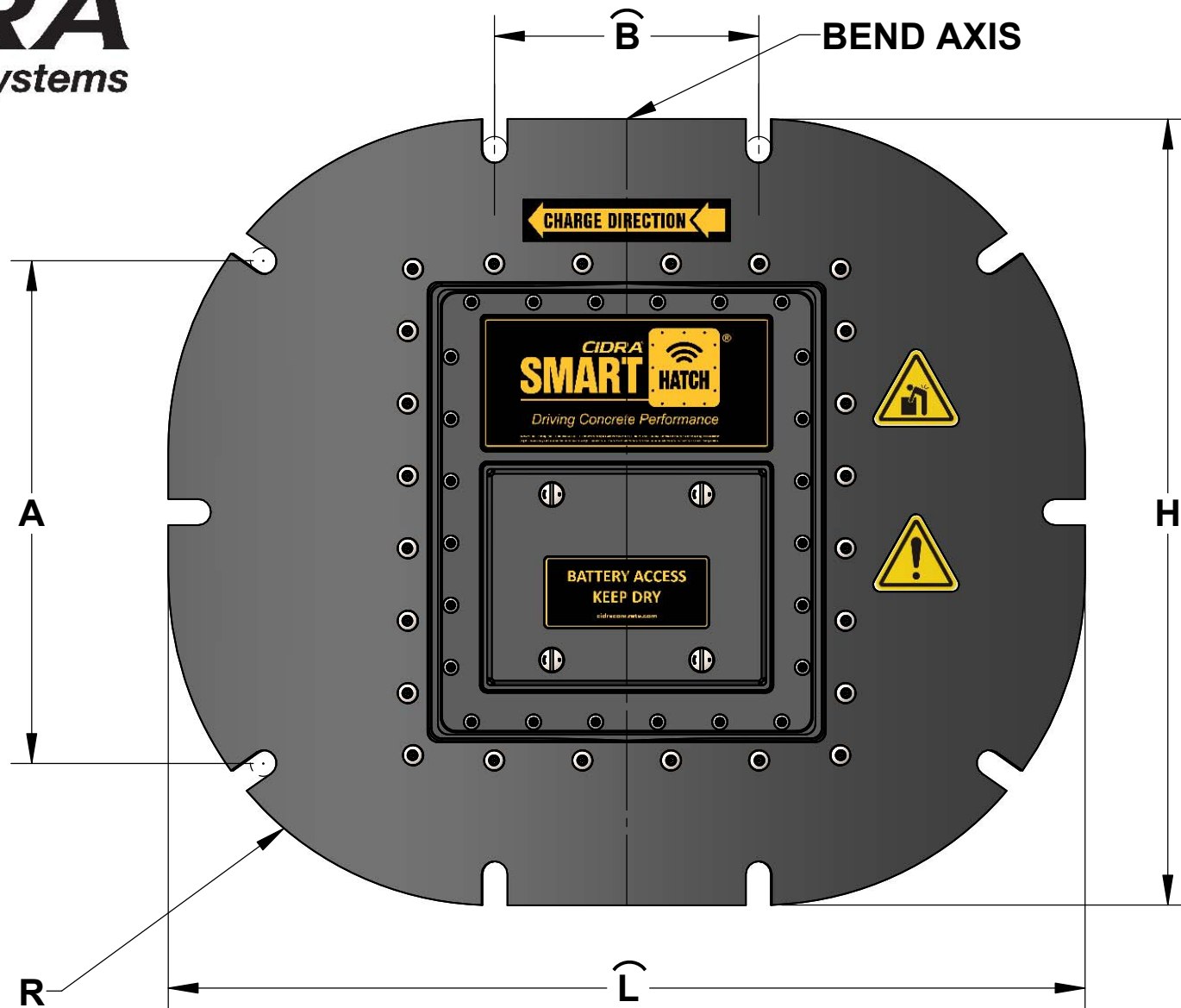

21715-00016 | ATMS-01-01-05-03-00-00-XX

TYPICALLY USED ON LONDON TRUCKS

Truck name does not guarantee hatch style, please verify all dimensions.

NOTES:

1. DIMENSIONS DENOTED BY $\widehat{}$ ARE TO BE MEASURED ON BEND RADIUS (ARC LENGTH).

$$\widehat{B} = 6\text{-}3/8''$$

$$A = 12\text{-}1/8''$$

$$\widehat{L} = 22\text{-}7/16''$$

$$R = 8''$$

$$H = 19''$$

CiDRA Concrete Systems Inc.
50 Barnes Park North
Wallingford, CT 06492
Main: +1.203.265.0035
Tech Support: +1.203.626.3430
smarthatchsupport@cidraconcrete.com
www.CidraConcrete.com

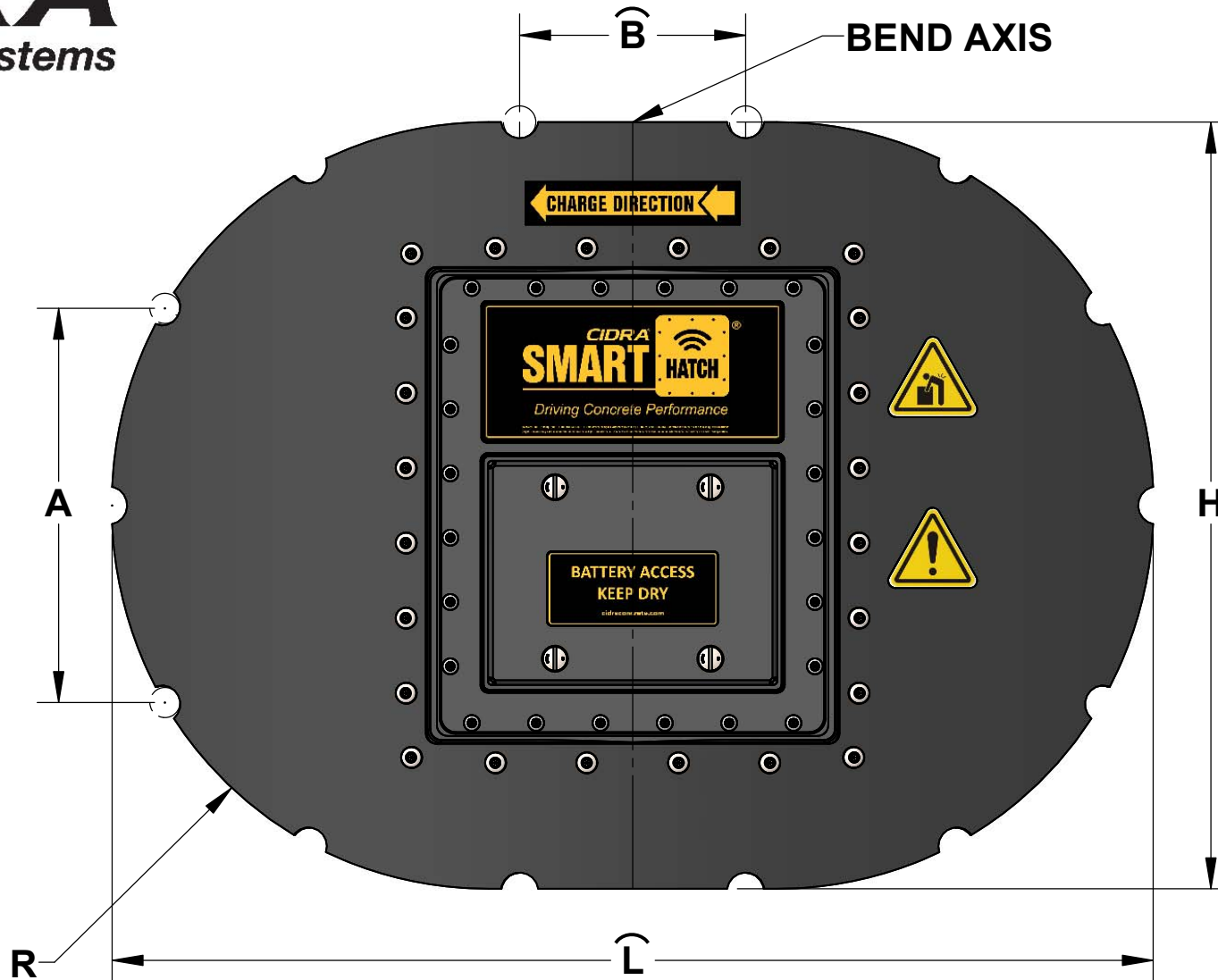

21715-00019 | ATMS-01-01-06-03-00-00-XX

TYPICALLY USED ON KIMBLE TRUCKS

Truck name does not guarantee hatch style, please verify all dimensions.

NOTES:

1. DIMENSIONS DENOTED BY $\widehat{}$ ARE TO BE MEASURED ON BEND RADIUS (ARC LENGTH).

$\widehat{B} = 5-1/4"$

$\widehat{L} = 24-11/16"$

$A = 9-3/16"$

$R = 8-15/16"$

$H = 17-7/8"$

CiDRA Concrete Systems Inc.
50 Barnes Park North
Wallingford, CT 06492
Main: +1.203.265.0035
Tech Support: +1.203.626.3430
smarthatchsupport@cidraconcrete.com
www.CidraConcrete.com

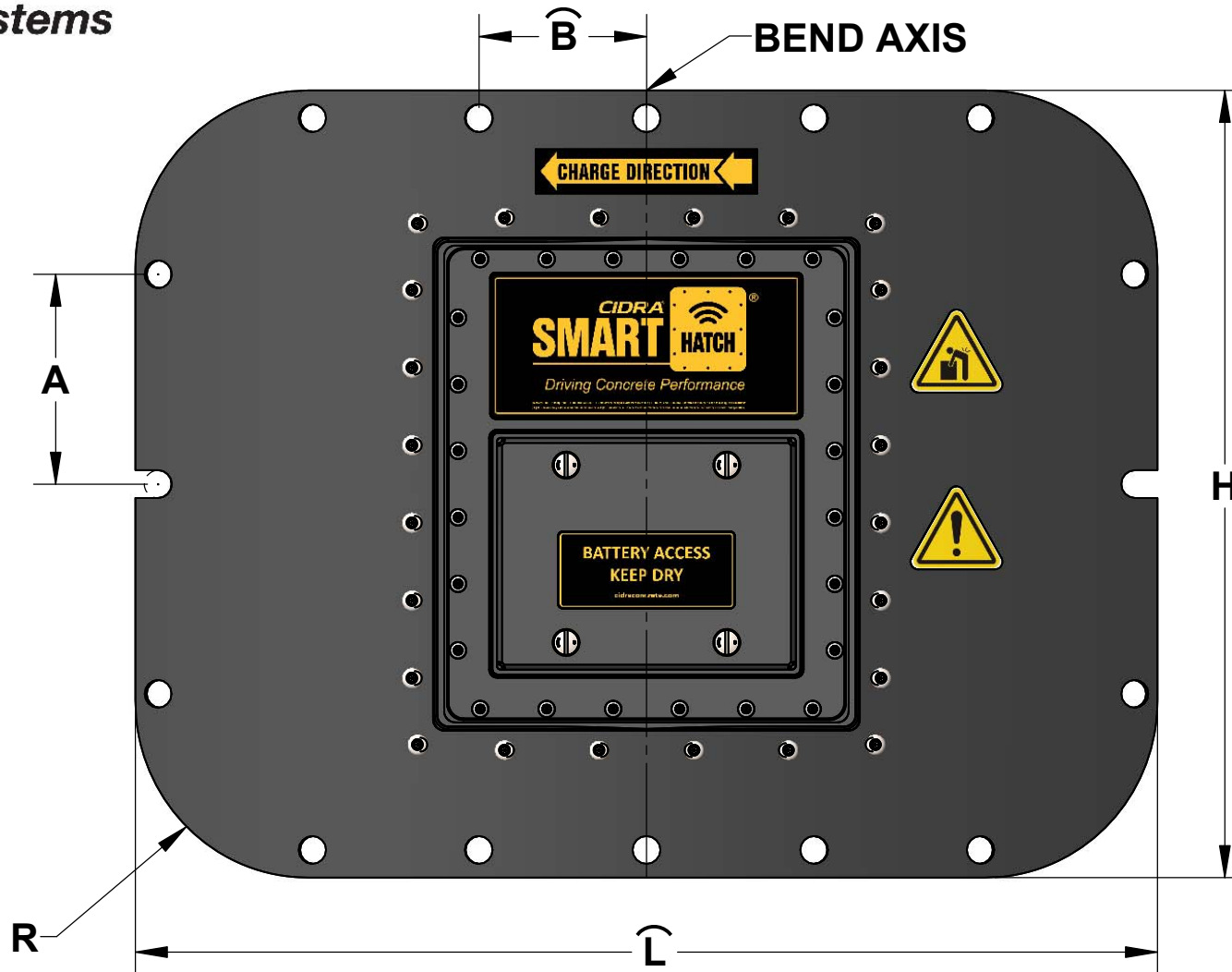

21715-00022 | ATMS-01-01-07-03-00-00-XX

TYPICALLY USED ON SCHWING TRUCKS

Truck name does not guarantee hatch style, please verify all dimensions.

NOTES:

1. DIMENSIONS DENOTED BY $\widehat{}$ ARE TO BE MEASURED ON BEND RADIUS (ARC LENGTH).

$\widehat{B} = 3-13/16"$
 $A = 4-3/4"$

$\widehat{L} = 23-3/8"$
 $R = 4"$

$H = 17-3/4"$

CiDRA Concrete Systems Inc.
50 Barnes Park North
Wallingford, CT 06492
Main: +1.203.265.0035
Tech Support: +1.203.626.3430
smarthatchsupport@cidraconcrete.com
www.CidraConcrete.com

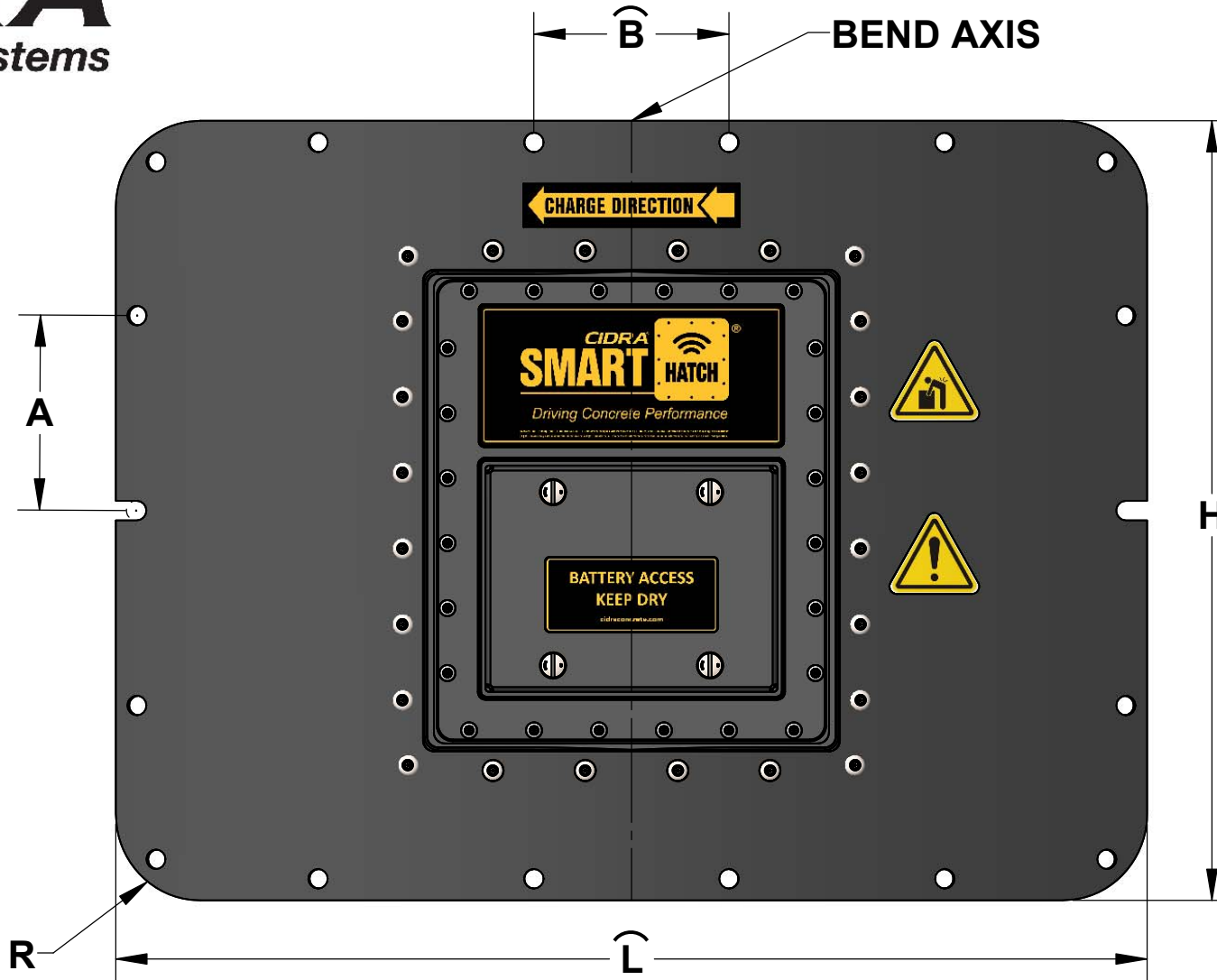

21715-00025 | ATMS-01-01-08-03-00-00-XX

TYPICALLY USED ON INDIANA PHOENIX TRUCKS

Truck name does not guarantee hatch style, please verify all dimensions.

NOTES:

1. DIMENSIONS DENOTED BY $\widehat{}$ ARE TO BE MEASURED ON BEND RADIUS (ARC LENGTH).

$\widehat{B} = 4\text{-}1/2\text{'}$
 $A = 4\text{-}1/2\text{'}$

$\widehat{L} = 24\text{-}1/16\text{'}$
 $R = 2\text{'}$

$H = 18\text{'}$

CiDRA Concrete Systems Inc.
50 Barnes Park North
Wallingford, CT 06492
Main: +1.203.265.0035
Tech Support: +1.203.626.3430
smarthatchsupport@cidraconcrete.com
www.CidraConcrete.com

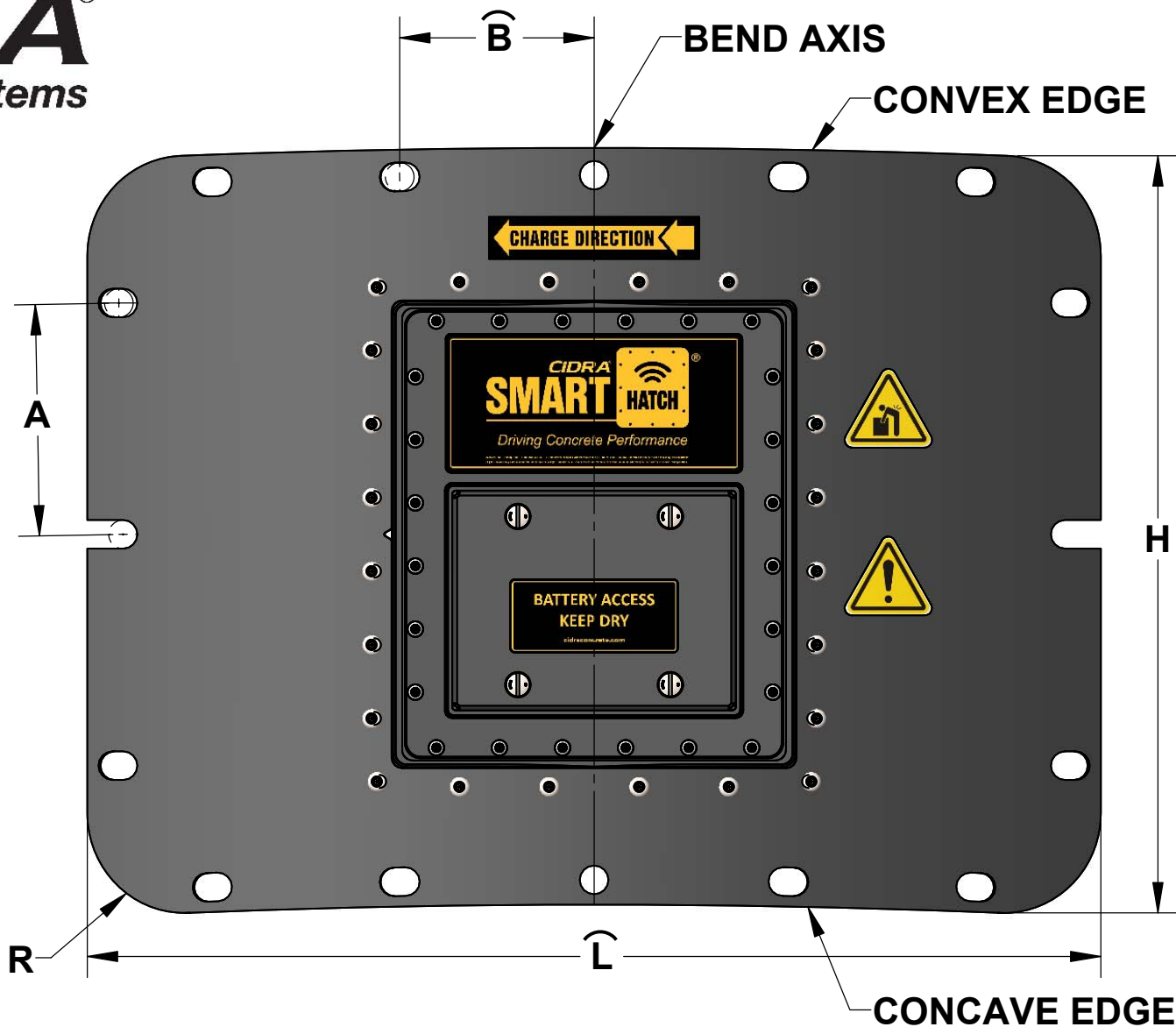

21715-00028 | ATMS-01-01-09-03-00-00-XX

TYPICALLY USED ON CONTINENTAL TRUCKS

Truck name does not guarantee hatch style, please verify all dimensions.

$$\widehat{B} = 4\text{-}5/8''$$

$$A = 5\text{-}1/2''$$

$$\widehat{L} = 24\text{-}3/8''$$

$$R = 2\text{-}3/8''$$

$$H = 18''$$

NOTES:

1. DIMENSIONS DENOTED BY $\widehat{}$ ARE TO BE MEASURED ON BEND RADIUS (ARC LENGTH).
2. HATCH HAS NON-SYMMETRIC FEATURES, VERIFY ORIENTATION TO BEND AXIS AND CHARGE DIRECTION.

CiDRA Concrete Systems Inc.
50 Barnes Park North
Wallingford, CT 06492
Main: +1.203.265.0035
Tech Support: +1.203.626.3430
smarthatchsupport@cidraconcrete.com
www.CidraConcrete.com

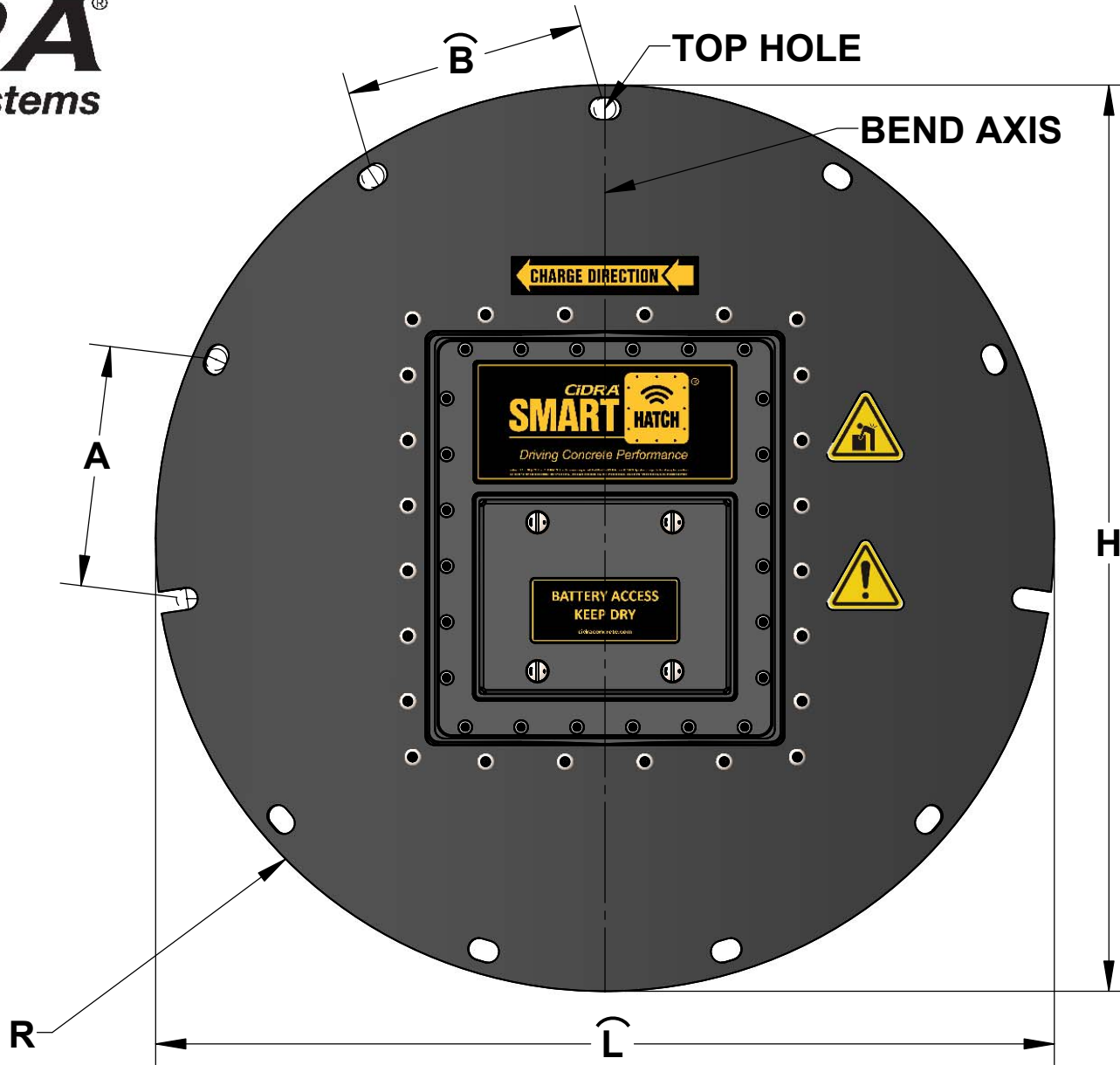

21715-00031 | ATMS-01-01-10-03-00-00-XX

TYPICALLY USED ON A & A DI MEDIO TRUCKS

Truck name does not guarantee hatch style, please verify all dimensions.

$\widehat{B} = 6-9/16''$
 $A = 6-7/16''$

$\widehat{L} = 24-7/16''$
 $R = 12-3/16''$

$H = 24-5/16''$

NOTES:

1. DIMENSIONS DENOTED BY $\widehat{}$ ARE TO BE MEASURED ON BEND RADIUS (ARC LENGTH).
2. HATCH HAS NON-SYMMETRIC FEATURES, VERIFY ORIENTATION TO BEND AXIS AND CHARGE DIRECTION.

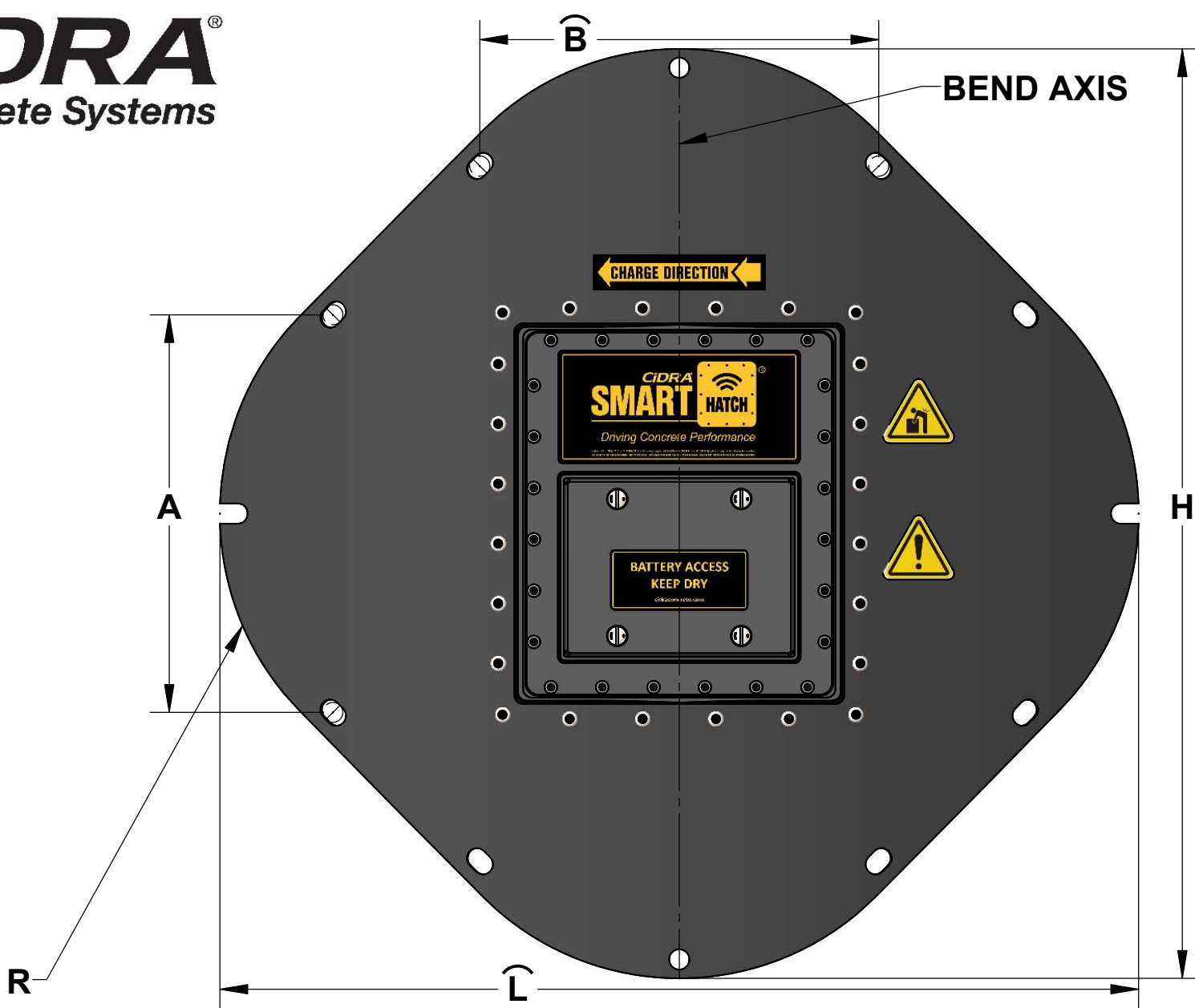

21715-00034 | ATMS-01-01-11-03-00-00-XX

TYPICALLY USED ON CESCO TRUCKS

Truck name does not guarantee hatch style, please verify all dimensions.

NOTES:

1. DIMENSIONS DENOTED BY $\widehat{}$ ARE TO BE MEASURED ON BEND RADIUS (ARC LENGTH).

$\widehat{B} = 11-13/16"$
 $A = 11-5/8"$

$\widehat{L} = 27-1/4"$
 $R = 8-1/16"$

$H = 27-3/16"$

CiDRA Concrete Systems Inc.
50 Barnes Park North
Wallingford, CT 06492
Main: +1.203.265.0035
Tech Support: +1.203.626.3430
smarthatchsupport@cidraconcrete.com
www.CidraConcrete.com

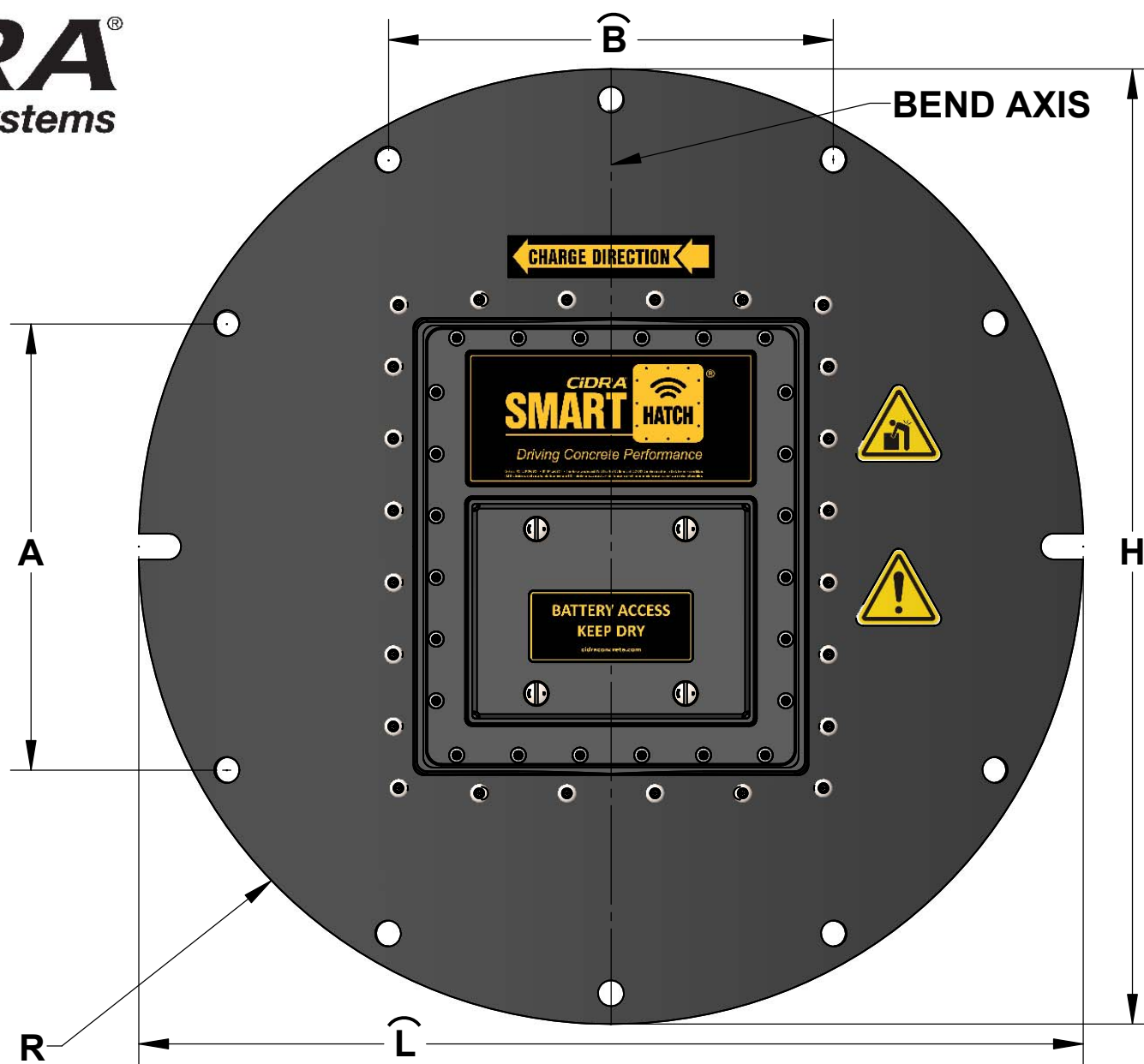

21715-00037 | ATMS-01-01-12-03-00-00-XX

TYPICALLY USED ON SCHWING-STETTER TRUCKS - VERSION 1 STYLE
Truck name does not guarantee hatch style, please verify all dimensions.

NOTES:

1. DIMENSIONS DENOTED BY $\widehat{}$ ARE TO BE MEASURED ON BEND RADIUS (ARC LENGTH).

$\widehat{B} = 10-7/8"$
 $A = 10-7/8"$

$\widehat{L} = 23-1/4"$
 $R = 11-5/8"$

$H = 23-1/4"$

CiDRA Concrete Systems Inc.
50 Barnes Park North
Wallingford, CT 06492
Main: +1.203.265.0035
Tech Support: +1.203.626.3430
smarthatchsupport@cidraconcrete.com
www.CidraConcrete.com

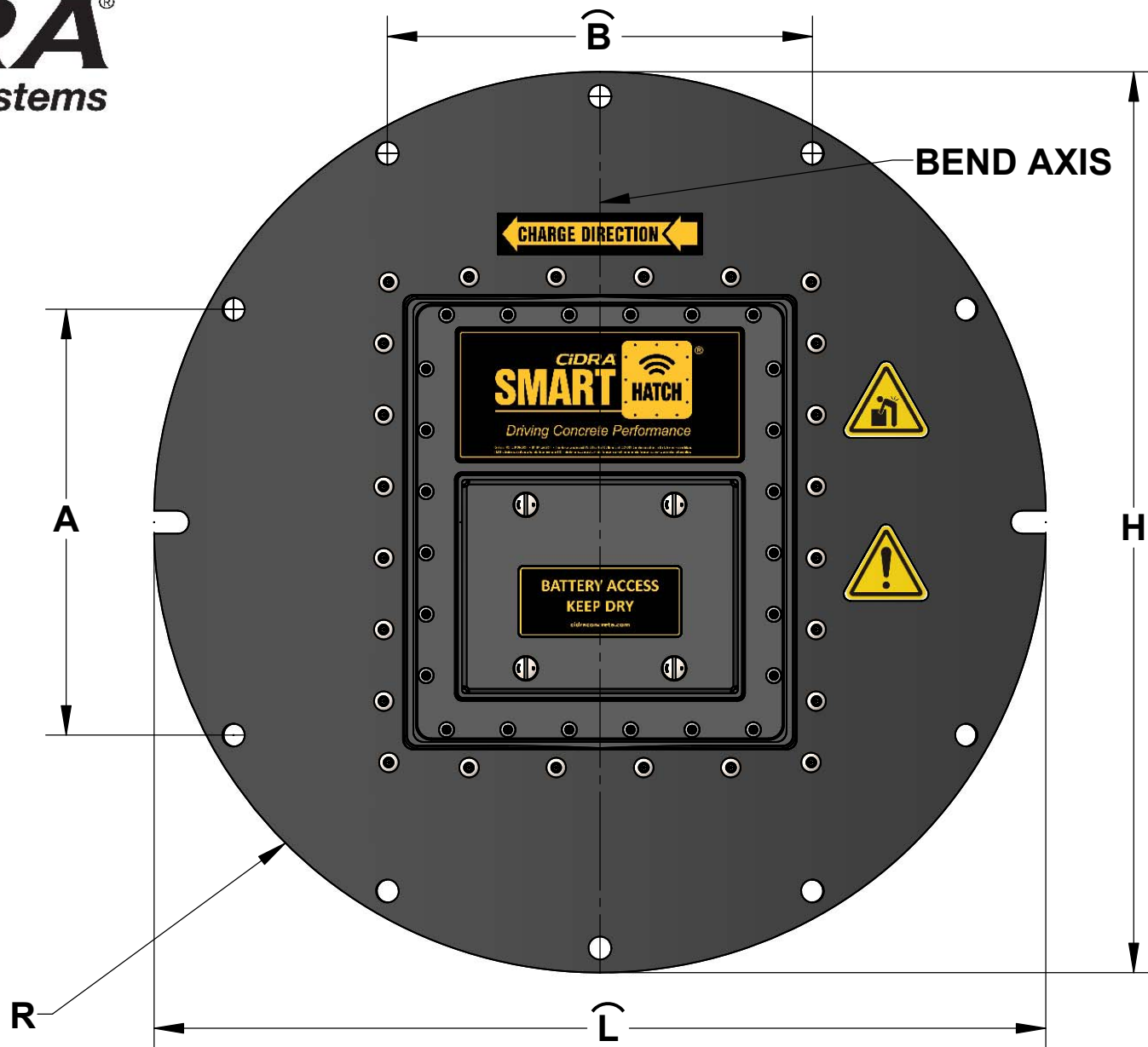

21715-00040 | ATMS-01-01-13-03-00-00-XX

TYPICALLY USED ON FOTON TRUCKS

Truck name does not guarantee hatch style, please verify all dimensions.

NOTES:

1. DIMENSIONS DENOTED BY $\widehat{}$ ARE TO BE MEASURED ON BEND RADIUS (ARC LENGTH).

$\widehat{B} = 10-7/16"$
 $A = 10-7/16"$

$\widehat{L} = 22"$
 $R = 11"$

$H = 22"$

CiDRA Concrete Systems Inc.
50 Barnes Park North
Wallingford, CT 06492
Main: +1.203.265.0035
Tech Support: +1.203.626.3430
smarthatchsupport@cidraconcrete.com
www.CidraConcrete.com

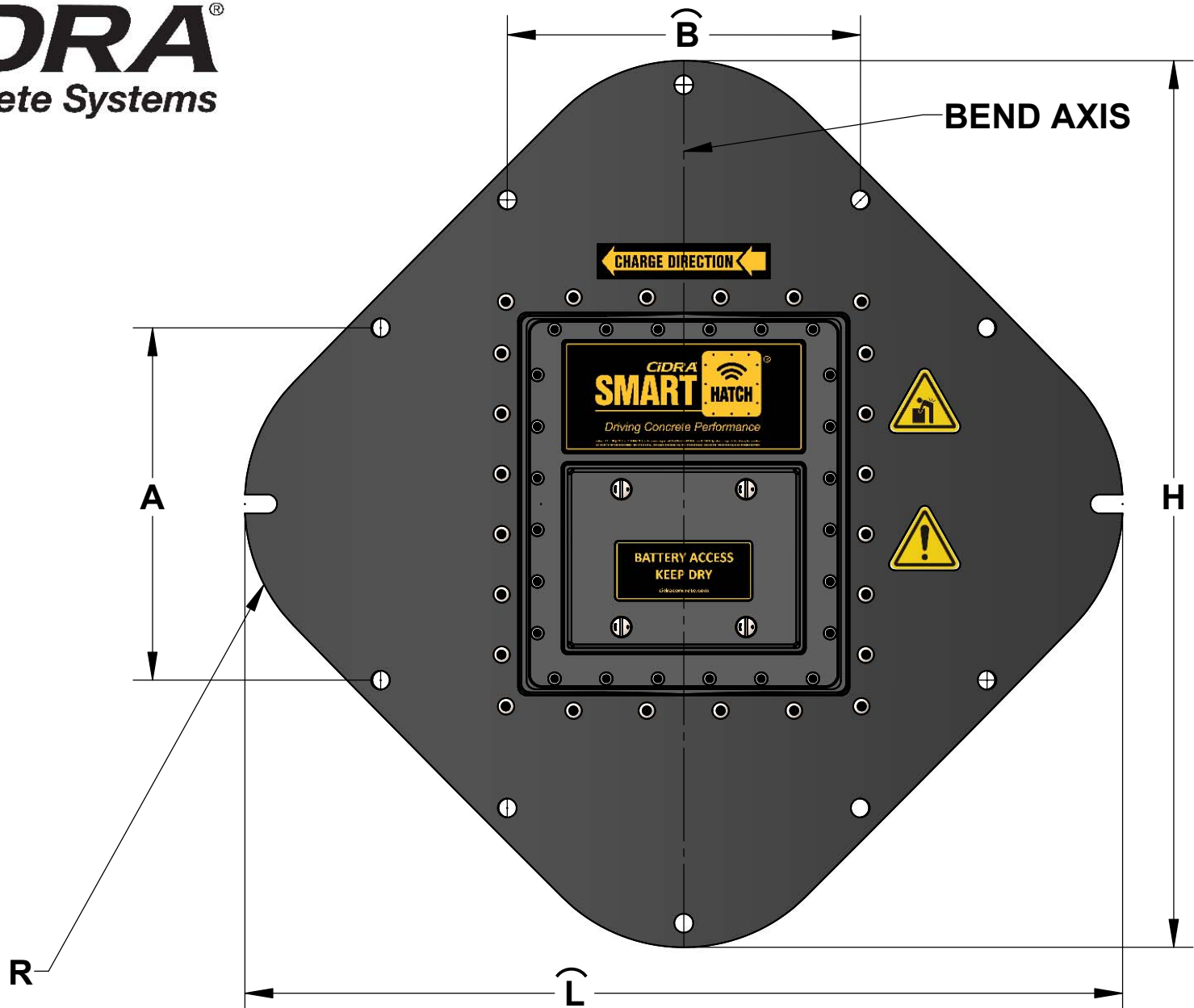

21715-00043 | ATMS-01-01-14-03-00-00-XX

TYPICALLY USED ON SINOTRUK TRUCKS

Truck name does not guarantee hatch style, please verify all dimensions.

NOTES:

1. DIMENSIONS DENOTED BY $\widehat{}$ ARE TO BE MEASURED ON BEND RADIUS (ARC LENGTH).

$$\widehat{B} = 10\text{-}1/4'' \quad \widehat{L} = 25\text{-}7/8''$$

$$A = 10\text{-}1/4'' \quad R = 5'' \quad H = 25\text{-}3/4''$$

CiDRA Concrete Systems Inc.
50 Barnes Park North
Wallingford, CT 06492
Main: +1.203.265.0035
Tech Support: +1.203.626.3430
smarthatchsupport@cidraconcrete.com
www.CidraConcrete.com

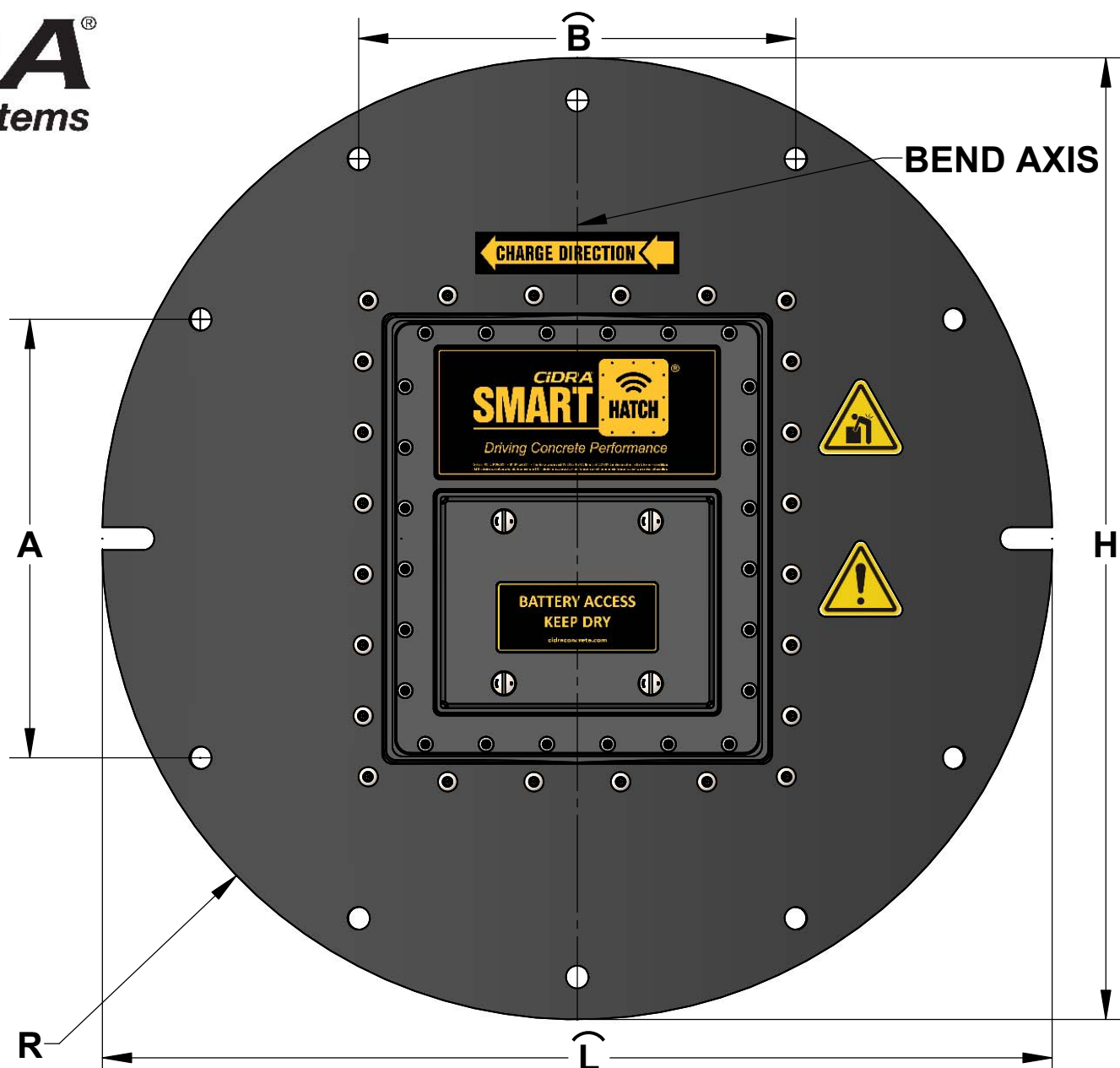

21715-00046 | ATMS-01-01-15-03-00-00-XX

TYPICALLY USED ON SINOTRUK TRUCKS

Truck name does not guarantee hatch style, please verify all dimensions.

NOTES:

1. DIMENSIONS DENOTED BY $\widehat{}$ ARE TO BE MEASURED ON BEND RADIUS (ARC LENGTH).

$$\widehat{B} = 10-13/16" \quad \widehat{L} = 23-3/4"$$

$$A = 10-13/16" \quad R = 11-7/8" \quad H = 23-3/4"$$

CiDRA Concrete Systems Inc.
50 Barnes Park North
Wallingford, CT 06492
Main: +1.203.265.0035
Tech Support: +1.203.626.3430
smarthatchsupport@cidraconcrete.com
www.CidraConcrete.com

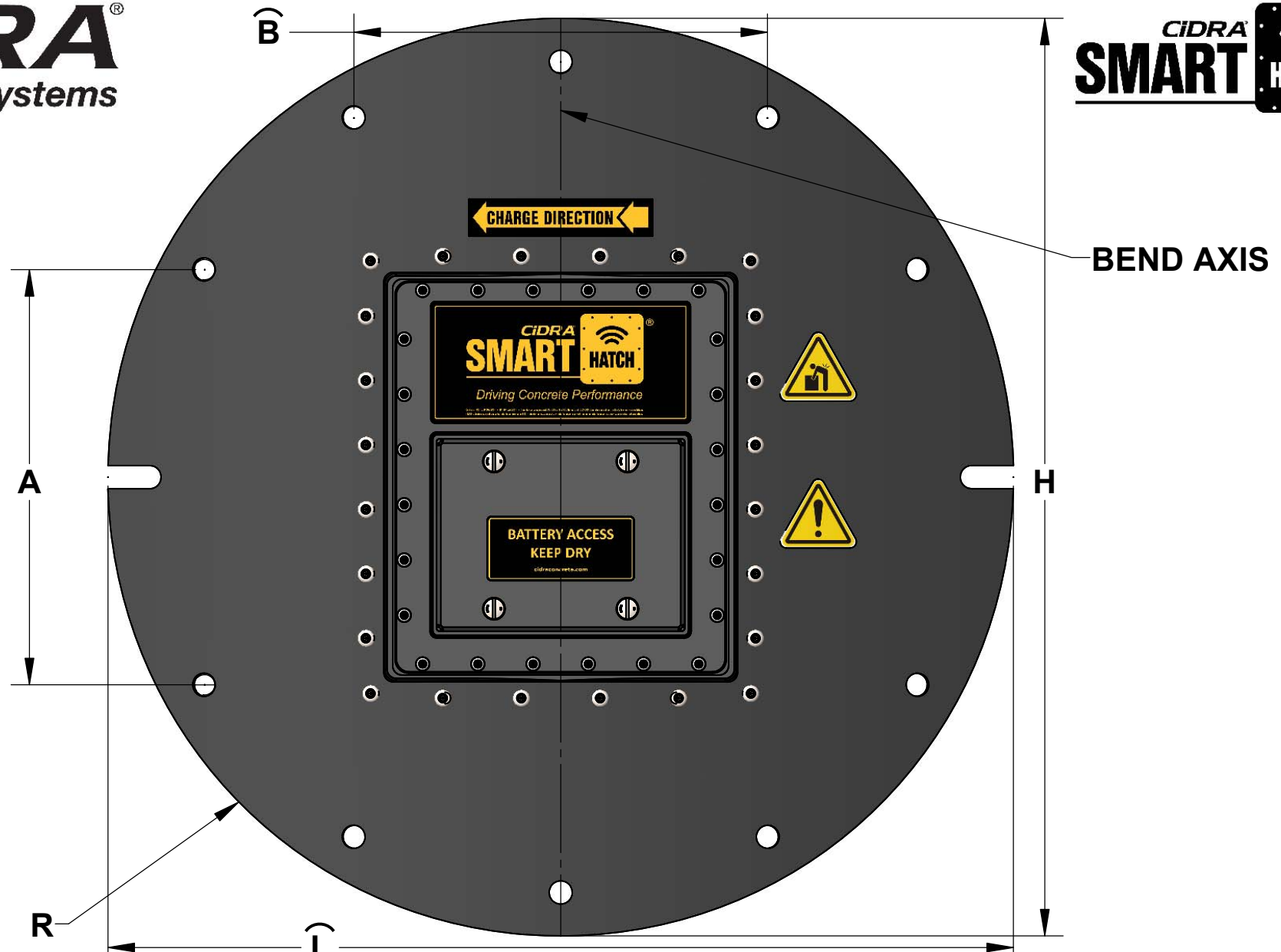

21715-00049 | ATMS-01-01-16-03-00-00-XX

TYPICALLY USED ON SCHWING-STETTER TRUCKS - VERSION 2 STYLE
Truck name does not guarantee hatch style, please verify all dimensions.

NOTES:

1. DIMENSIONS DENOTED BY $\widehat{}$ ARE TO BE MEASURED ON BEND RADIUS (ARC LENGTH).

$\widehat{B} = 11-1/4"$	$\widehat{L} = 24-15/16"$		
$A = 11-1/4"$	$R = 12-7/16"$	$H = 24-15/16"$	

CiDRA Concrete Systems Inc.
50 Barnes Park North
Wallingford, CT 06492
Main: +1.203.265.0035
Tech Support: +1.203.626.3430
smarthatchsupport@cidraconcrete.com
www.CidraConcrete.com